

 **MISUTONIDA**  
  *italian style* **4x4**  
*accessories*

***TOYOTA HI-LUX DOUBLE CAB***



Item Code

***GP/208/IX***

Codice Articolo

***GPO/208/IX***

Référence Article

***DSP/208/IX***

**GB**

STAINLESS STEEL GRAND PEDANA OVAL  
GRAND PEDANA/DESIGN SIDE PROTECTION









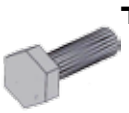

**ITA**

GRAND PEDANA/ GRAND PEDANA OVALE/  
PROTEZIONE LATERALE DESIGN IN ACCIAIO INOX

**FR**

GRAND PEDANA/ GRAND PEDANA OVALE/  
PROTECTION LATERALE DESIGN EN ACCIER  
INOX

# TOYOTA HI-LUX DOUBLE CAB

Part List Lista della bulloneria Liste des pièces	
<b>A</b>  <b>TE 10X50</b> Black Nero Noir x 4	<b>I</b>  <b>S/171/A-SX</b> x 1
<b>B</b>  <b>M10</b> autoblocking autobloccante autobloquant x 4	<b>L</b>  <b>S/171/A-DX</b> x 1
<b>C</b>  <b>TE 8X20</b> x 6	
<b>D</b>  <b>Ø 8</b> x 8	
<b>E</b>  <b>Ø 8</b> x 8	
<b>F</b>  <b>M8</b> x 2	
<b>G</b>  <b>S/171/P-SX</b> x 1	
<b>H</b>  <b>S/171/P-DX</b> x 1	

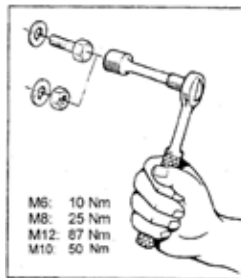
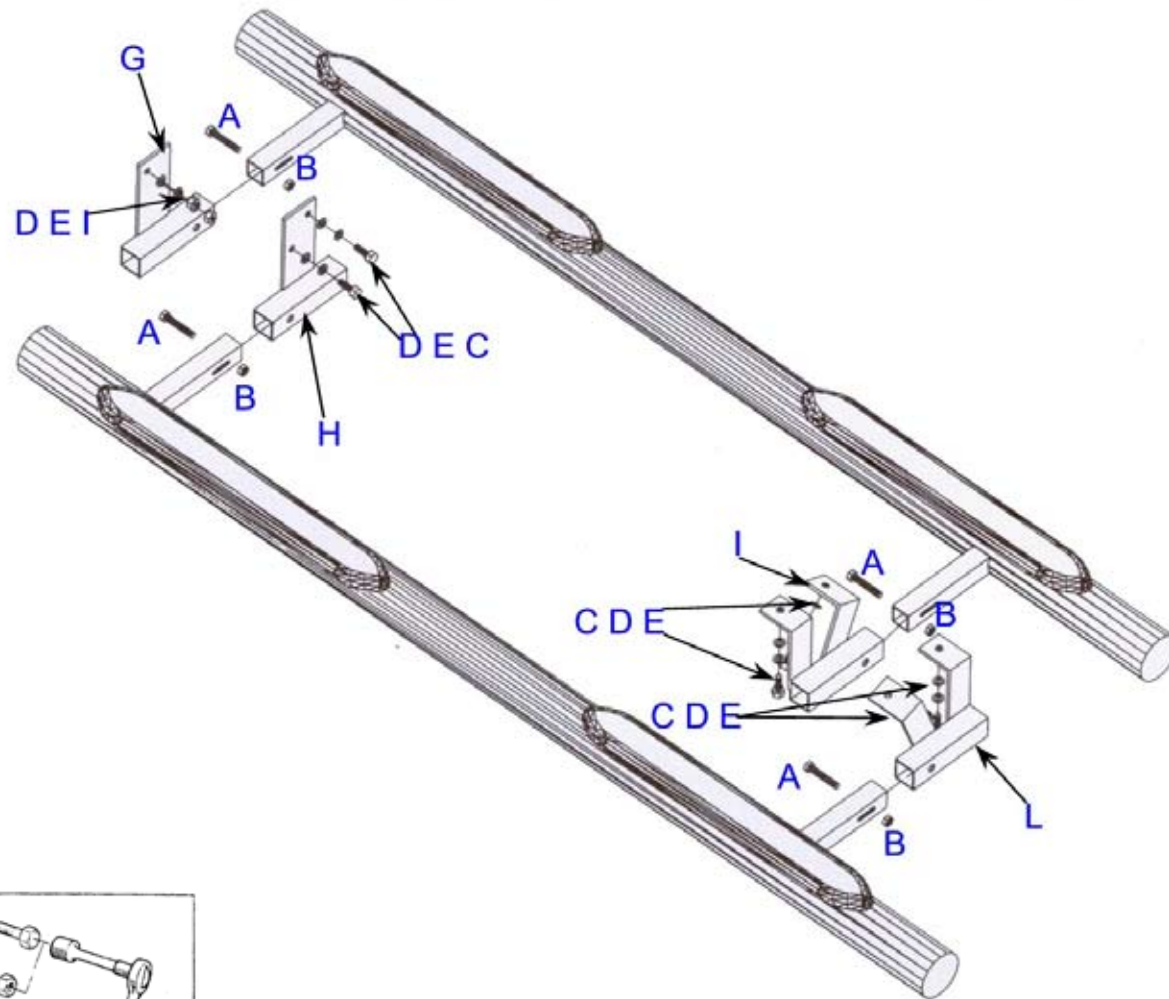

**MISUTONIDA**  
italian style accessories **4x4**



Date Data <i>Date</i>	Item Code Cod.Articolo <i>Réf. Article</i>	Vehicle model Modello Veicolo <i>Modèle de Voiture</i>
28/09/07	GP/208/IX GPO/208/IX DSP/208/IX	TOYOTA HI-LUX 2006 DOUBLE CAB

Checked and approved by  
**Controllato ed approvato da**  
*Controlé et approuvé par*

**Claudio  
 Gallo**

 **MISUTONIDA**  
  *italian style* **4x4**  
*accessories*